

Features
<ul style="list-style-type: none"> • 3G/GSM • PCB Type • Stable And Reliable Performance • 824-960MHz & 1710-2170MHz • Compact Size With Efficient Reception

Applications
<ul style="list-style-type: none"> • GSM/3G Position Routers & Tracking Systems • Automotive Sensors • Smart Outdoor Devices • Machine To Machine Wireless Communication • Mobile Systems



Part Numbering Guide

S AT PC 75A8FF CE B4

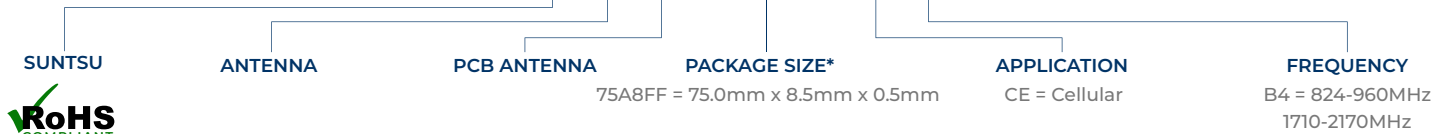

* Where letters denote decimal location (A=0, B=1, C=2, etc.); e.g. B5=0.15, 3A5=3.05, 9A=9.0



Electrical Parameters (GPS)	Units	Minimum	Typical	Maximum	Remarks
Frequency Band	MHz	824		960	
Impedance	Ω		50		
Polarization			Linear		
Peak Gain	dBi		0.6		At 890MHz
Efficiency	%		40		At 890MHz
VSWR				3	At Center Frequency
Operating Temperature	C	-40		85	

Electrical Parameters (GPS)	Units	Minimum	Typical	Maximum	Remarks
Frequency Band	MHz	1710		2170	
Impedance	Ω		50		
Polarization			Linear		
Peak Gain	dBi		3.9		At 1950MHz
Efficiency	%		67		At 1950MHz
VSWR				3	At Center Frequency
Operating Temperature	C	-40		85	

Outline Drawing

All dimensions are in millimeters (mm) unless otherwise noted. Drawings are not to scale.

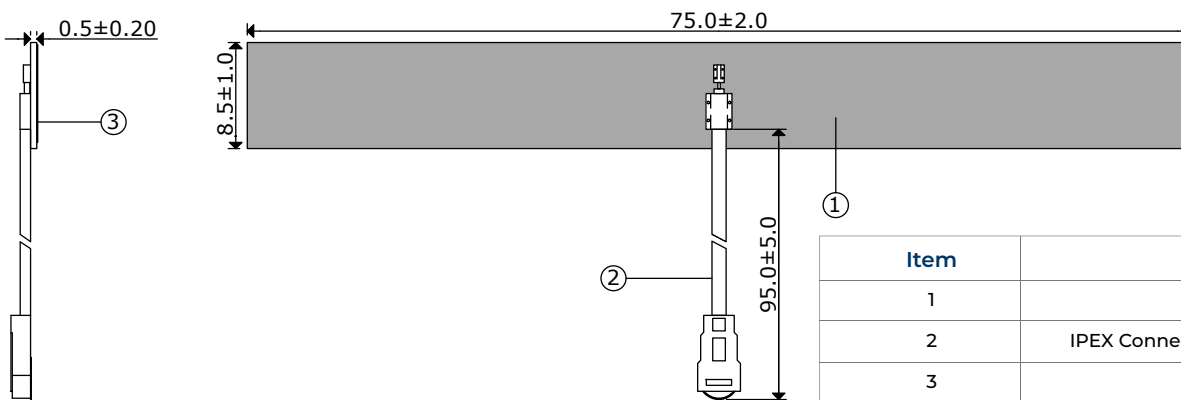

Item	Material
1	FR4 PCB
2	IPEX Connector and Cable with OD of 1.13
3	Adhesive Tape

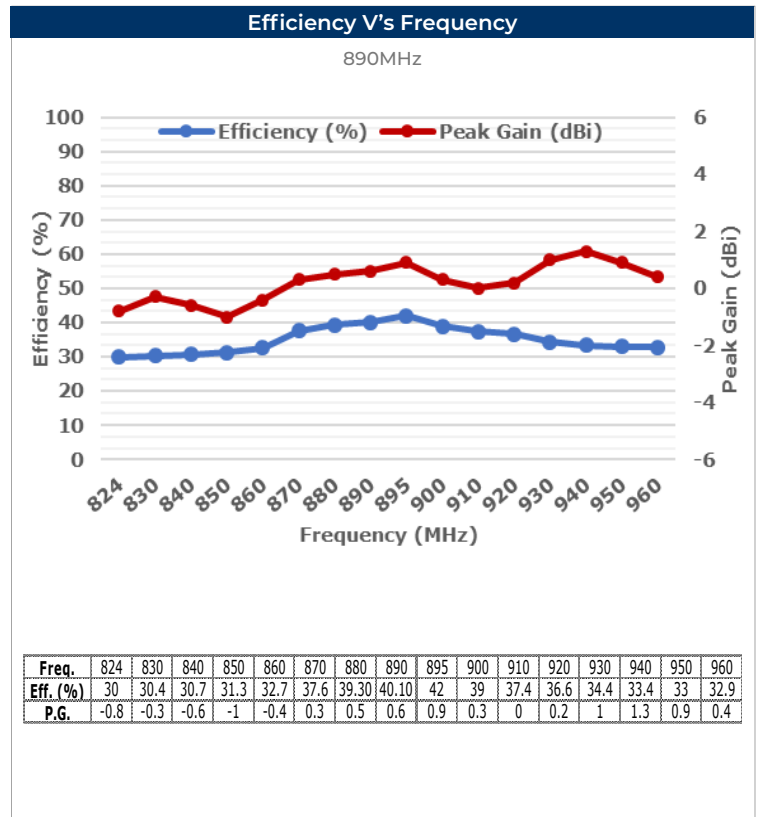
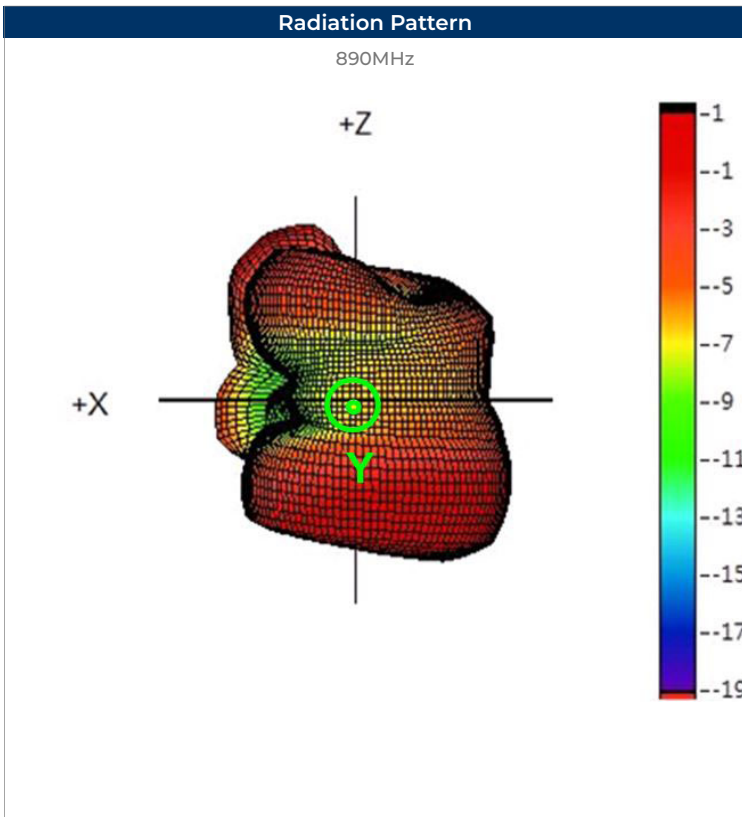
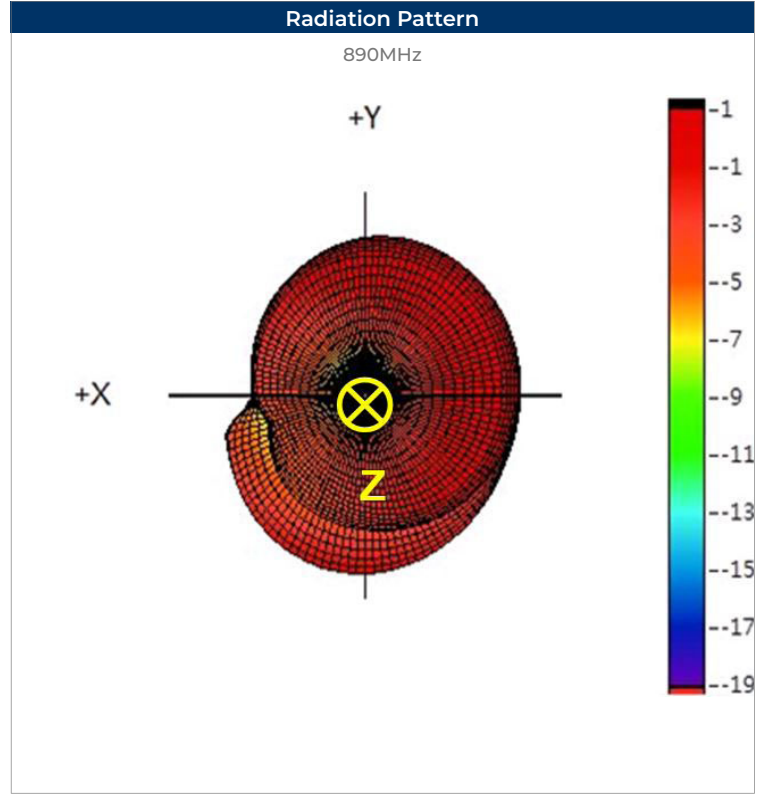
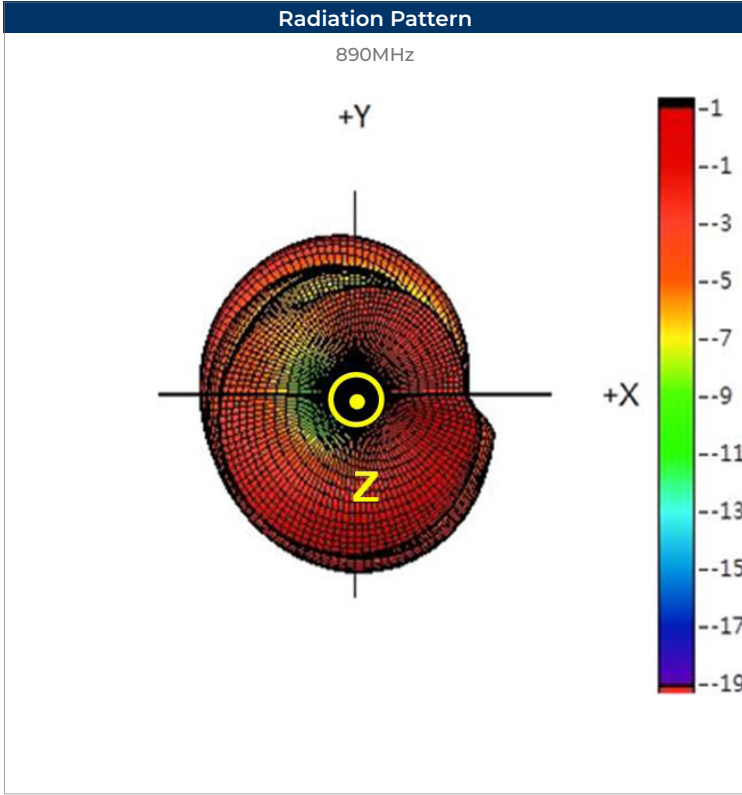

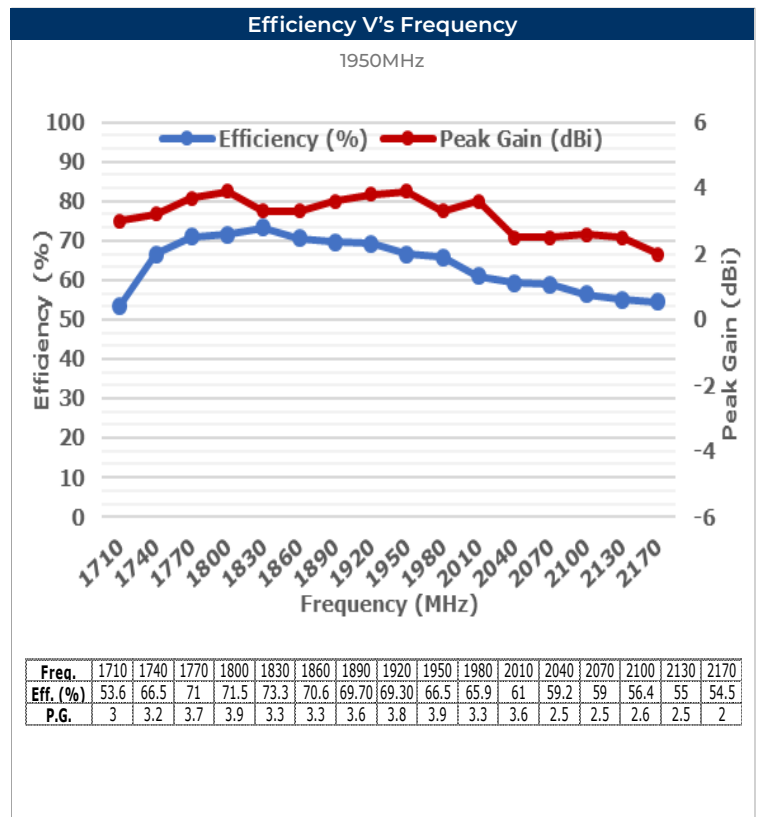
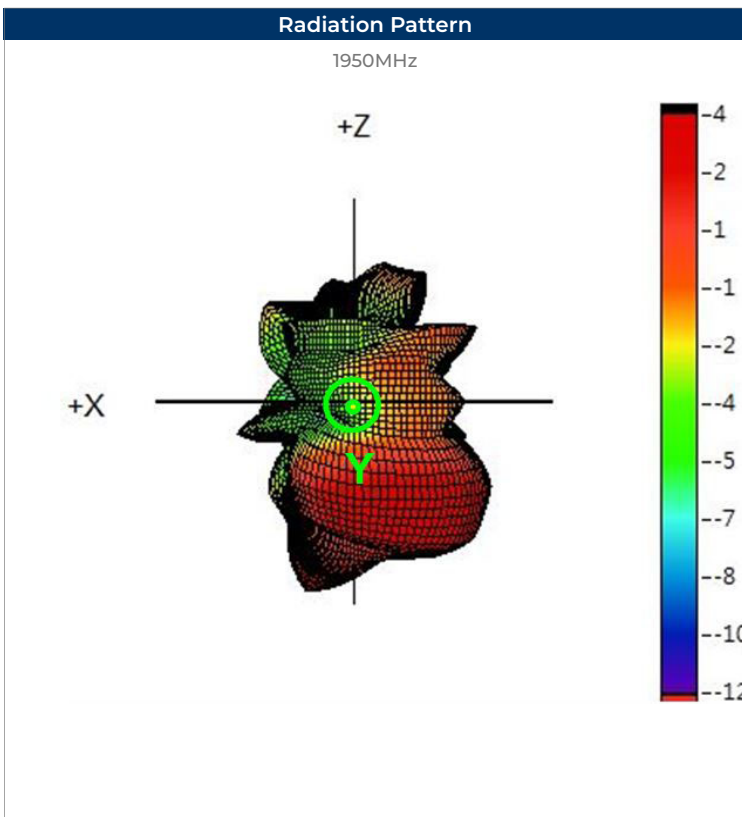
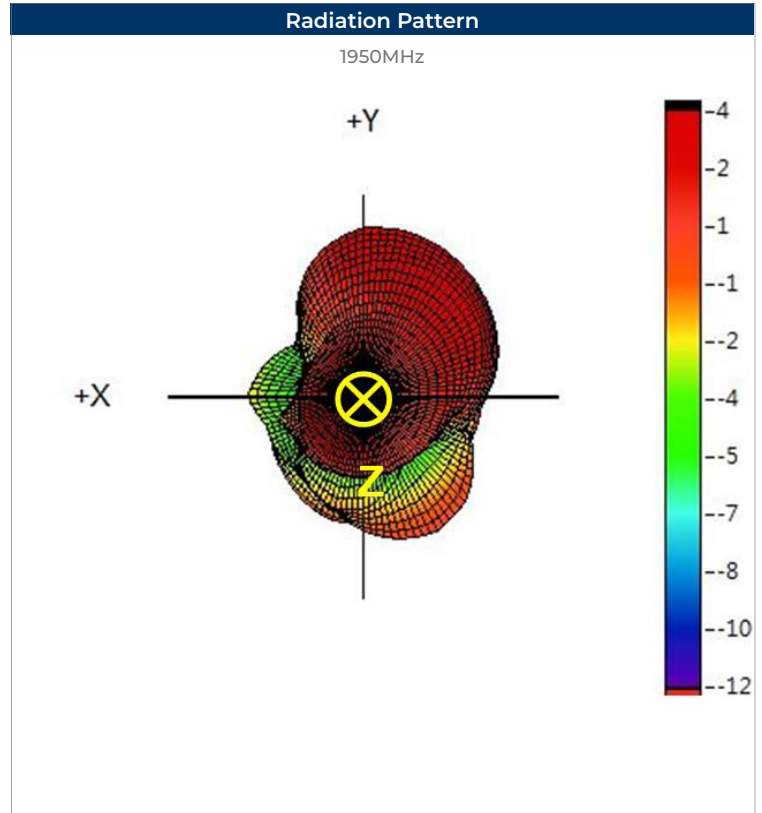
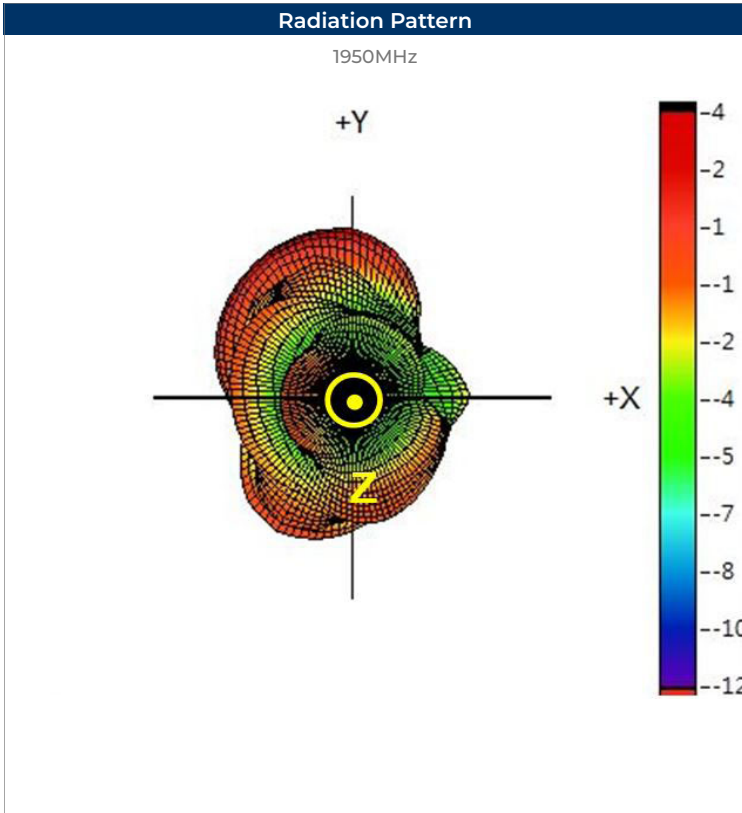

Electrical Test

Return Loss

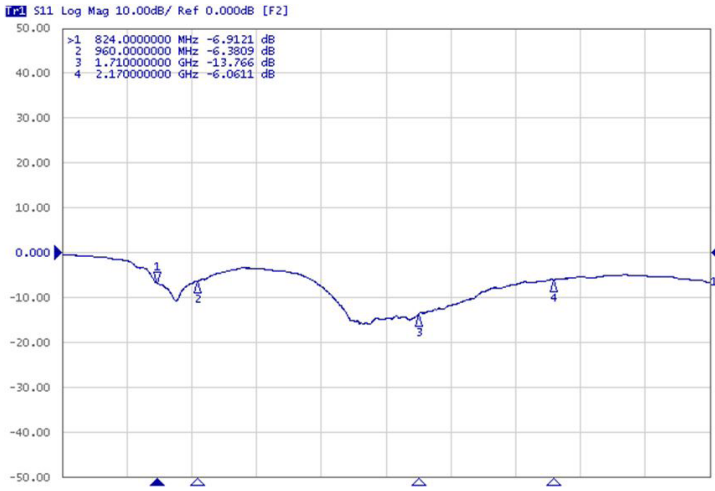

Electrical Test

VSWR

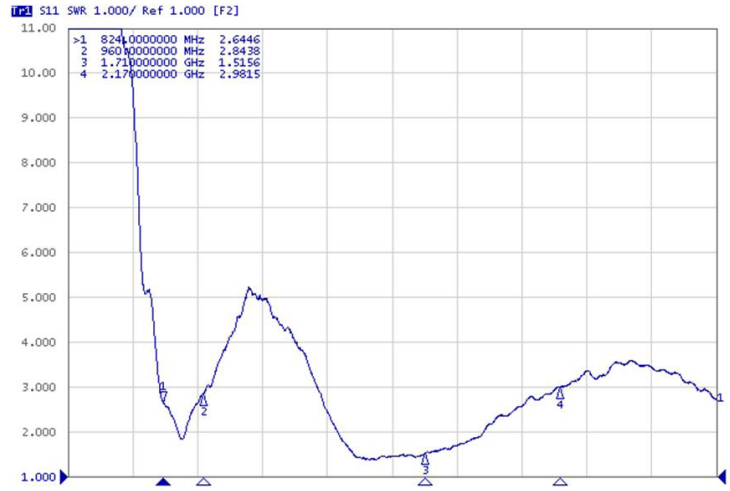

Environmental & Mechanical Specifications

High Temperature Test	85°C for 240 hours, and then to normal temperature/humidity High Temperature Test for 24hours.
Low Temperature Test	-30°C for 240 hours, and then to normal temperature/humidity for 24hours.
Humidity Test	85°C / 90-95%RH for 48 hours, and then to normal temperature/humidity for 24hours.
Thermal Shock Test	-30°C for 30 min and +85°C for 30 min. 5 cycles, then expose to normal temperature/humidity for 24 hours or more.
Vibration Test	5 to 200 to 5Hz, swept in 10min, 4.5G at max(2mm amplitude), in X and Y directions for 2 hours each and in Z direction for 4 hours.