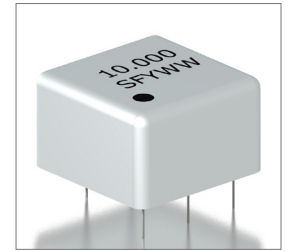
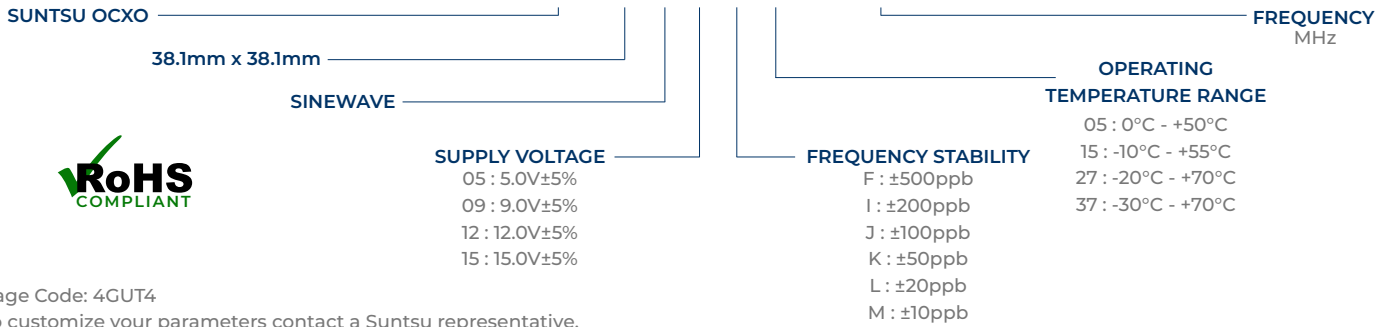

Features
<ul style="list-style-type: none"> <li>±10ppb (Frequency Stability) Available</li> <li>Sinewave</li> <li>OCXO</li> </ul>

Applications
<ul style="list-style-type: none"> <li>Military Communication Equipment</li> <li>Base Stations</li> <li>Test Equipment</li> <li>Synthesizers</li> <li>Digital Switching</li> </ul>

**Part Numbering Guide**
**SOC 38 S 12 K 27 - 10.000M**

Cage Code: 4GUT4

To customize your parameters contact a Suntsu representative.

Electrical Parameters	Units	Minimum	Typical	Maximum	Remarks
Frequency Range	MHz	5		100	
Frequency Tolerance at +25°C	ppb	-100		+100	
Freq. Stability vs. Op Temp.	ppb	-10		+10	See part numbering guide for options.
Freq. Stability vs. Supply Voltage	ppb	-2		+2	V <sub>DD</sub> ±5% Change
Freq. Stability vs. Load	ppb	-2		+2	±10% Change
Freq. Stability vs. Aging/Year	ppb	-50		+50	See part numbering guide for options.
Operating Temperature	°C	-30		+70	See part numbering guide for options.
Storage Temperature	°C	-45		+85	
Supply Voltage (V <sub>DD</sub> )	V	V <sub>DD</sub> -5%	V <sub>DD</sub>	V <sub>DD</sub> +5%	
Power Consumption At Turn On	W			4.5	
Power Consumption At 25°C	W			1.8	
Control Voltage (V <sub>c</sub> )	V	0.0		5.0	
Control Middle Voltage	V		2.5		
Pullability	ppm	±0.7			
Linearity	%			10	
V <sub>c</sub> Input Impedance	KΩ	50			
Deviation Slope			Positive		
Output Logic (SINEWAVE) Load	Ω			50	
Output Logic Waveform	dBm	7			
Output Logic Spurious (Harmonic)	dBc			-30	
Output Logic Spurious (Non-Harmonic)	dBc			-70	
Reference Voltage Output (V <sub>ref</sub> )	V			5	
Symmetry (Duty Cycle)	%	45	50	55	
Start-Up Time	ms			3	At 25°C After 5Mins.
Warm-Up Time	ppb	-100		100	

## Outline Drawing & Part Marking

All dimensions are in millimeters (mm) unless otherwise noted. Drawings are not to scale.

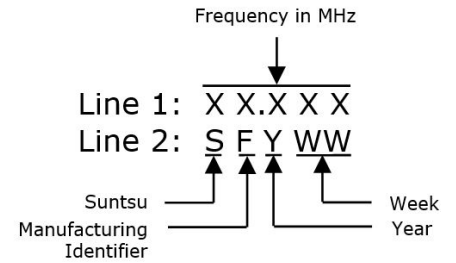
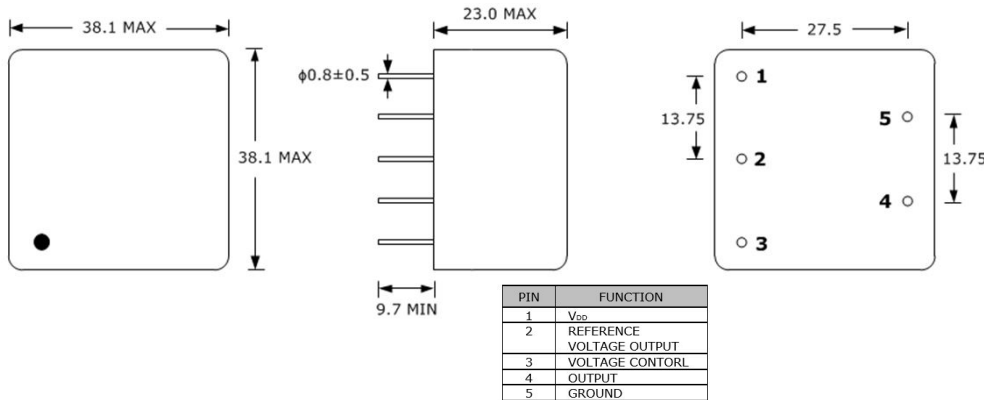

## Test Circuit (Sinewave)

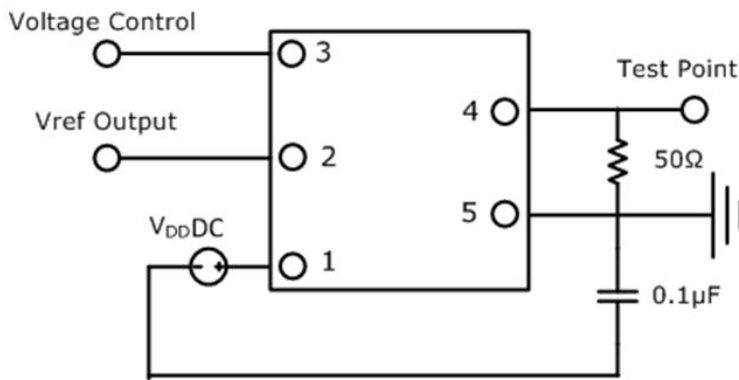

## Waveform (Sinewave)

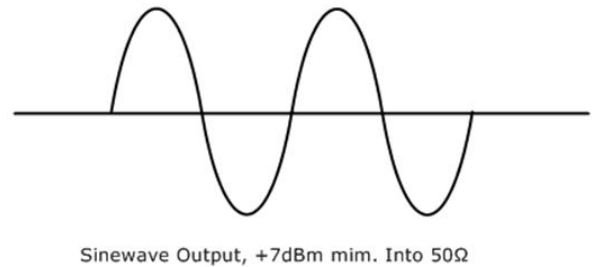

## Typical Phase Noise And Jitter Performance (Measured By Agilent E5052A)

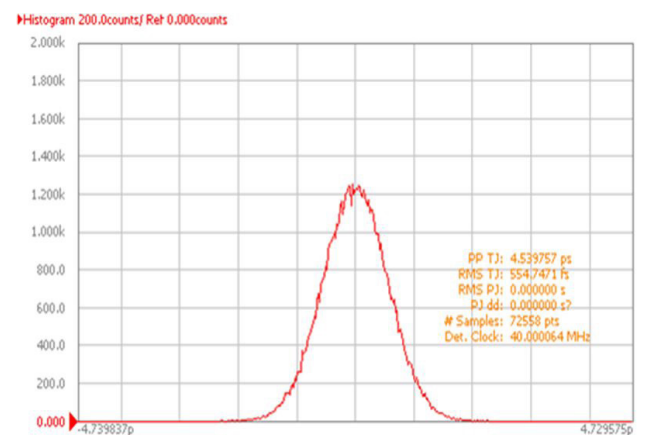
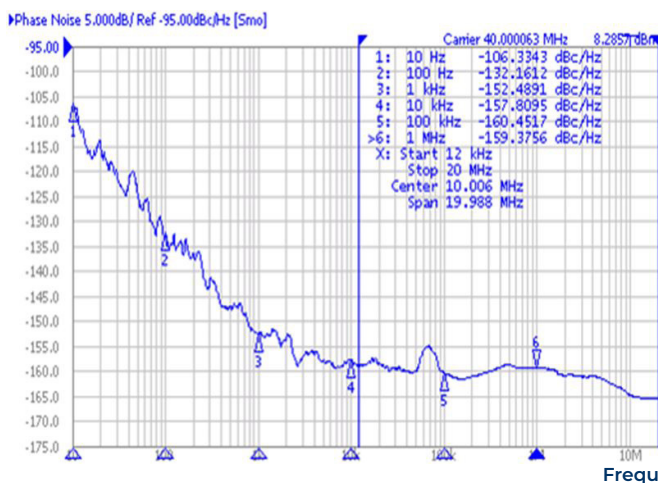

Environmental Specifications		Mechanical Specifications	
Temperature Cycling	MIL-STD-883, Method 1010, Condition B	Mechanical Shock	MIL-STD-202, Method 213, Condition B
Lead Integrity	MIL-STD-883, Method 1014, Condition A	Vibration	MIL-STD-883, Method 2007, Condition A
Gross Leak Test	MIL-STD-883, Method 1014, Condition C	Resistance to Soldering Heat	MIL-STD-202, Method 210, Condition A
Solderability	MIL-STD-883, Method 2003	Resistance to Solvents	MIL-STD-202, Method 215