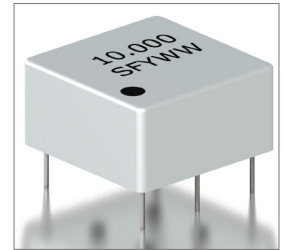
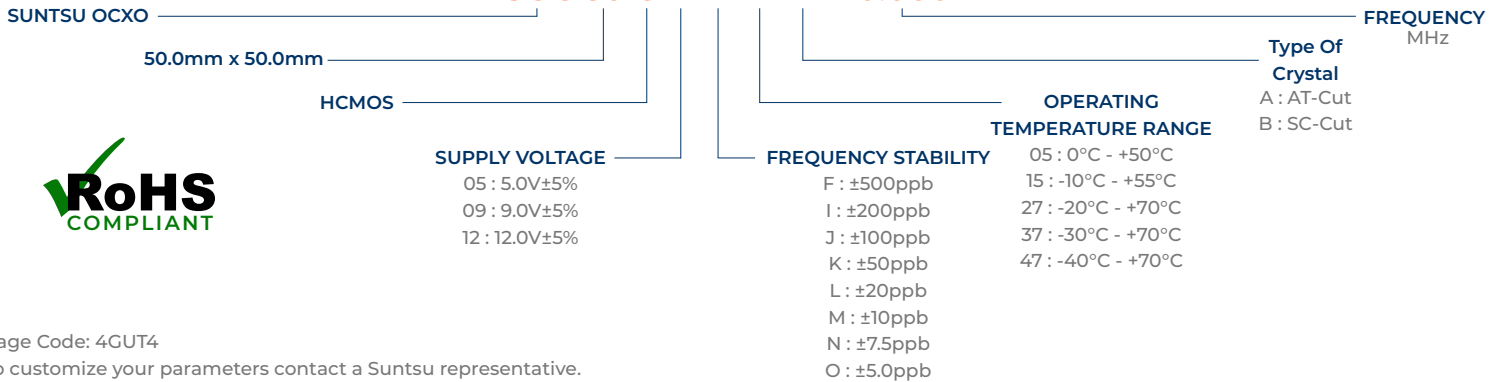

Features
<ul style="list-style-type: none"> ±5.0ppb (Frequency Stability) Available HCMOS/TTL OCXO AT-Cut or SC-Cut

Applications
<ul style="list-style-type: none"> Military Communication Equipment Base Stations Test Equipment Synthesizers Digital Switching

Part Numbering Guide
SOC 50 C 12 K 47 A - 10.000M

Cage Code: 4GUT4

To customize your parameters contact a Suntsu representative.

Electrical Parameters	Units	Minimum	Typical	Maximum	Remarks
Frequency Range	MHz	5		100	
Frequency Tolerance at +25°C	ppb	-100		+100	
Freq. Stability vs. Op Temp.	ppb	-50		+50	See part numbering guide for options.
Freq. Stability vs. Supply Voltage	ppb	-5		+5	V _{DD} ±5% Change
Freq. Stability vs. Load	ppb	-5		+5	±10% Change
Freq. Stability vs. Aging/Year	ppb	±50		±300	AT-Cut : ±300/Year, SC-Cut : ±50/Year
Operating Temperature	°C	-40		+70	See part numbering guide for options.
Storage Temperature	°C	-50		+90	
Supply Voltage (V _{DD}) - 5.0V Option	V	4.750	5.0	5.250	
Supply Voltage (V _{DD}) - 9.0V Option	V	8.550	9.0	9.450	
Supply Voltage (V _{DD}) - 12.0V Option	V	11.40	12.0	12.60	
Power Consumption At Turn On	W			6.0	
Power Consumption At 25°C	W			2.0	
Control Voltage (V _c)	V	0.5		5.0	
Control Middle Voltage	V		2.5		
Pullability (AT-Cut)	ppm	±2.0			AT-Cut
Pullability (SC-Cut)	ppm	±0.5			SC-Cut
Linearity	%			10	
V _c Input Impedance	KΩ	20			
Deviation Slope			Positive		
Output Logic (HCMOS)	pF			15	
Output Logic Level - High (V _{OH})	V	0.9*V _{DD}			
Output Logic Level - Low (V _{OL})	V			0.1*V _{DD}	
Reference Voltage Output (V _{ref})	V			5	
Symmetry (Duty Cycle)	%	40	50	60	
Warm-Up Time	ppb	-50		50	At 25°C After 5Mins.

Outline Drawing & Part Marking

All dimensions are in millimeters (mm) unless otherwise noted. Drawings are not to scale.

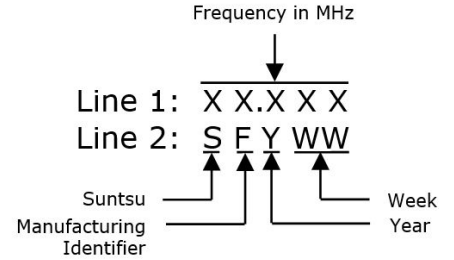
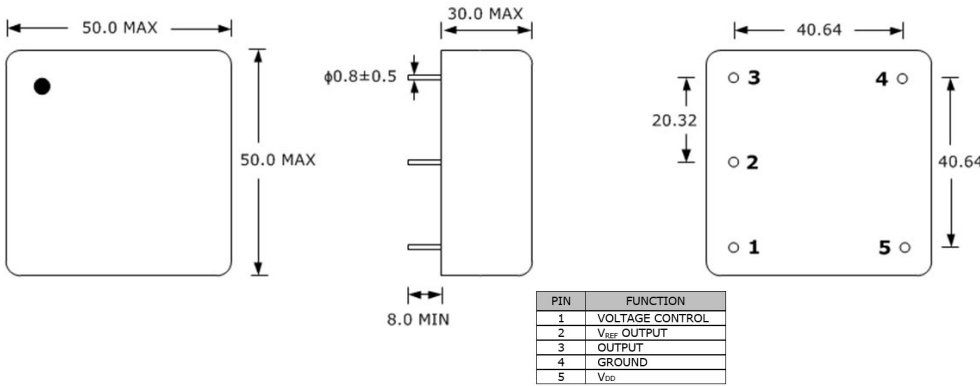

Test Circuit (HCMOS)

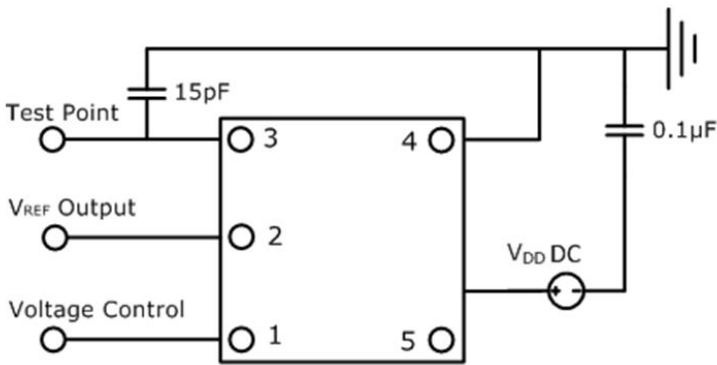

Waveform (HCMOS)

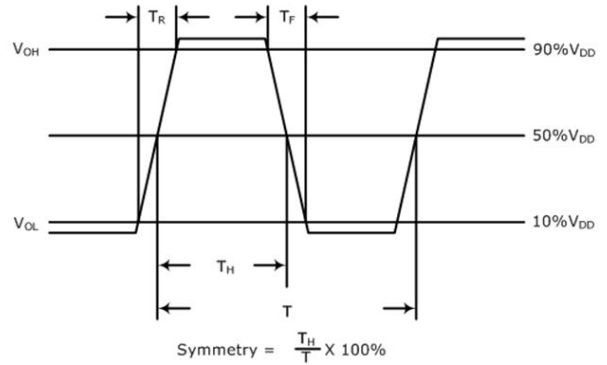

Typical Phase Noise And Jitter Performance (Measured By Agilent E5052A)

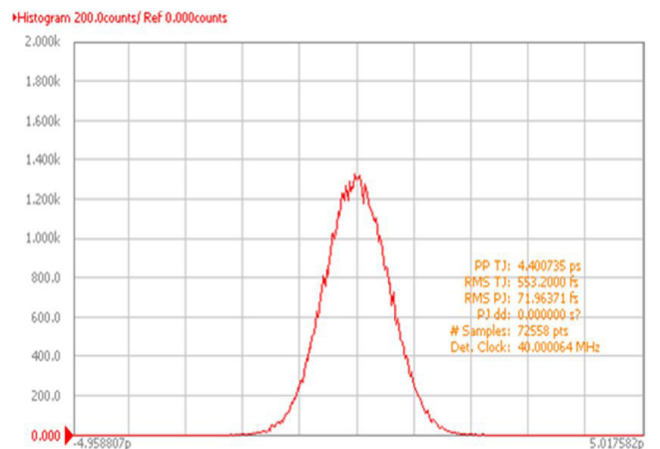
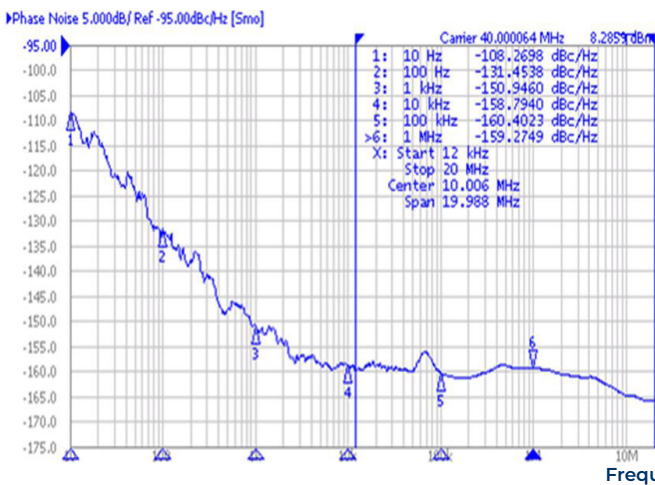

Environmental Specifications		Mechanical Specifications	
Temperature Cycling	MIL-STD-883, Method 1010, Condition B	Mechanical Shock	MIL-STD-202, Method 213, Condition B
Lead Integrity	MIL-STD-883, Method 1014, Condition A	Vibration	MIL-STD-883, Method 2007, Condition A
Gross Leak Test	MIL-STD-883, Method 1014, Condition C	Resistance to Soldering Heat	MIL-STD-202, Method 210, Condition A
Solderability	MIL-STD-883, Method 2003	Resistance to Solvents	MIL-STD-202, Method 215