

Features
<ul style="list-style-type: none"> ±50ppb (Frequency Stability) Available HCMOS OCXO Small Package

Applications
<ul style="list-style-type: none"> Military Communication Equipment Base Stations Test Equipment Synthesizers Digital Switching

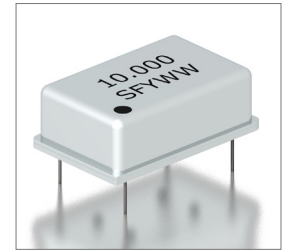

Part Numbering Guide

SOC F S C 05 K 15 - 10.000M

SUNTSU OCXO

FULL SIZE

HCMOS



Cage Code: 4GUT4
To customize your parameters contact a Suntsu representative.

SUPPLY VOLTAGE

05 : 5.0V±5%

09 : 9.0V±5%

12 : 12.0V±5%

FREQUENCY STABILITY

F : ±500ppb

I : ±200ppb

J : ±100ppb

K : ±50ppb

FREQUENCY
MHz

OPERATING TEMPERATURE RANGE

05 : 0°C - +50°C

15 : -10°C - +55°C

27 : -20°C - +70°C

37 : -30°C - +70°C

47 : -40°C - +70°C

Electrical Parameters	Units	Minimum	Typical	Maximum	Remarks
Frequency Range	MHz	10		80	
Frequency Tolerance at +25°C	ppb	-100		+100	
Freq. Stability vs. Op Temp.	ppb	-50		+50	See part numbering guide for options.
Freq. Stability vs. Supply Voltage	ppb	-20		+20	V _{DD} ±5% Change
Freq. Stability vs. Load	ppb	-20		+20	±10% Change
Freq. Stability vs. Aging/Year	ppb	-4.6		+4.6	For 10 Years
Operating Temperature	°C	-20		+60	See part numbering guide for options.
Storage Temperature	°C	-45		+85	
Supply Voltage (V _{DD}) - 5.0V Option	V	4.750	5.0	5.250	
Supply Voltage (V _{DD}) - 9.0V Option	V	8.550	9.0	9.450	
Supply Voltage (V _{DD}) - 12.0V Option	V	11.400	12.0	12.600	
Power Consumption At Turn On	W			2.5	
Power Consumption At 25°C	W			1.0	
Control Voltage (V _c)	V	0.5		4.5	
Control Middle Voltage	V		2.5		
Pullability	ppm	±3.0	±5.0	±8.0	
Linearity	%			10	
V _c Input Impedance	KΩ	50			
Deviation Slope			Positive		
Output Logic (HCMOS)	pF			15	
Output Logic Level - High (V _{OH})	V	0.9*V _{DD}			
Output Logic Level - Low (V _{OL})	V			0.1*V _{DD}	
Rise Time (T _R) And Fall Time (T _F)	ns			5	
Symmetry (Duty Cycle)	%	45	50	55	
Start-Up Time	ms			3	
Warm-Up Time	ppb	-100		100	At 25°C After 20Mins.

Outline Drawing & Part Marking

All dimensions are in millimeters (mm) unless otherwise noted. Drawings are not to scale.

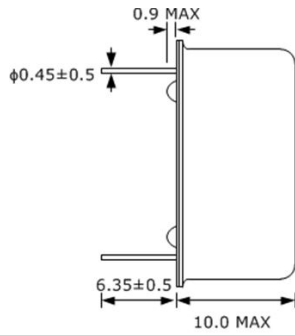
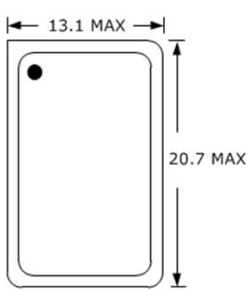

PIN	FUNCTION
1	VOLTAGE CONTROL
2	GND
3	OUTPUT
4	V _{DD}

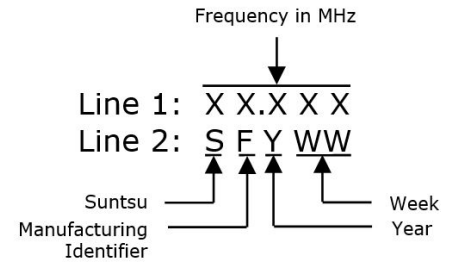
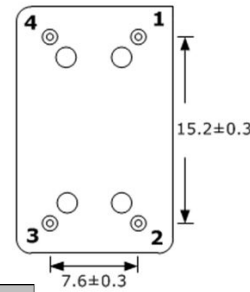

Test Circuit (HCMOS)

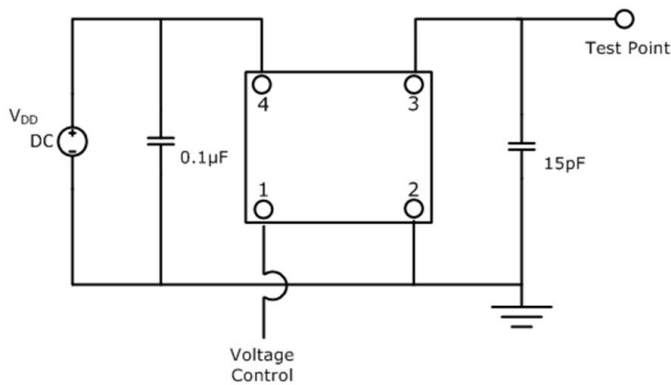

Waveform (HCMOS)

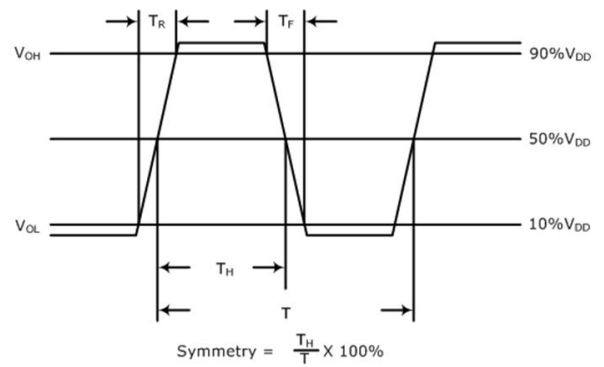

Typical Phase Noise And Jitter Performance (Measured By Agilent E5052A)

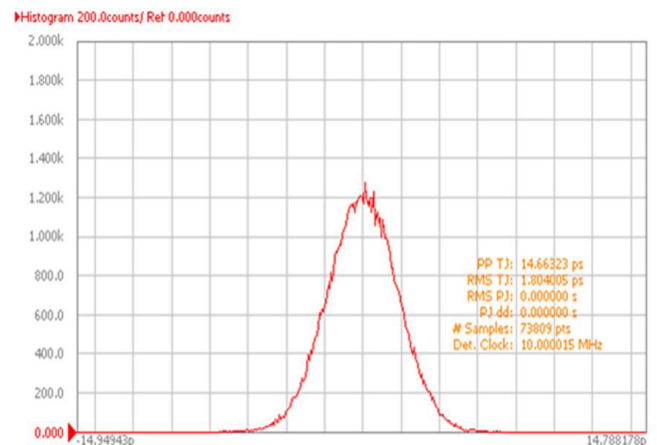
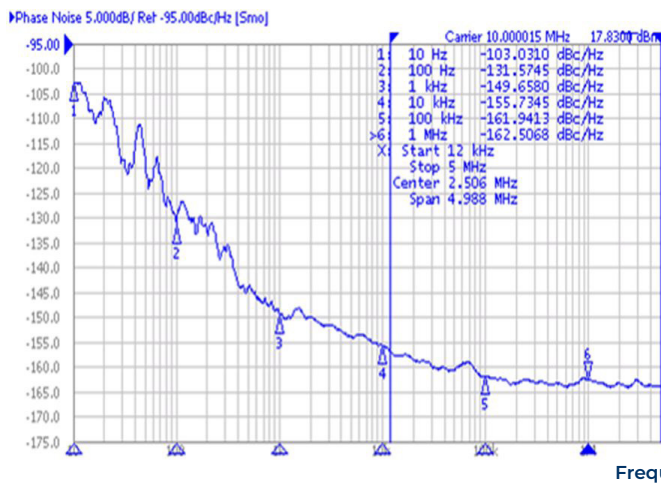

Environmental Specifications		Mechanical Specifications	
Temperature Cycling	MIL-STD-883, Method 1010, Condition B	Mechanical Shock	MIL-STD-202, Method 213, Condition B
Lead Integrity	MIL-STD-883, Method 1014, Condition A	Vibration	MIL-STD-883, Method 2007, Condition A
Gross Leak Test	MIL-STD-883, Method 1014, Condition C	Resistance to Soldering Heat	MIL-STD-202, Method 210, Condition A
Solderability	MIL-STD-883, Method 2003	Resistance to Solvents	MIL-STD-202, Method 215