

Features
<ul style="list-style-type: none"> <li>±1.0ppm (Frequency Stability) Available</li> <li>CMOS</li> <li>(VC)TCXO</li> </ul>

Applications
<ul style="list-style-type: none"> <li>Communication equipment</li> <li>Base Station</li> <li>FAX</li> </ul>

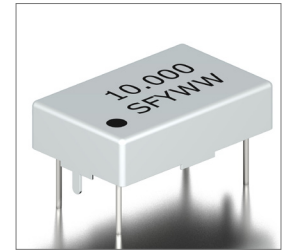

### Part Numbering Guide

**STC FS C 33 R 48 V E - 10.000M**

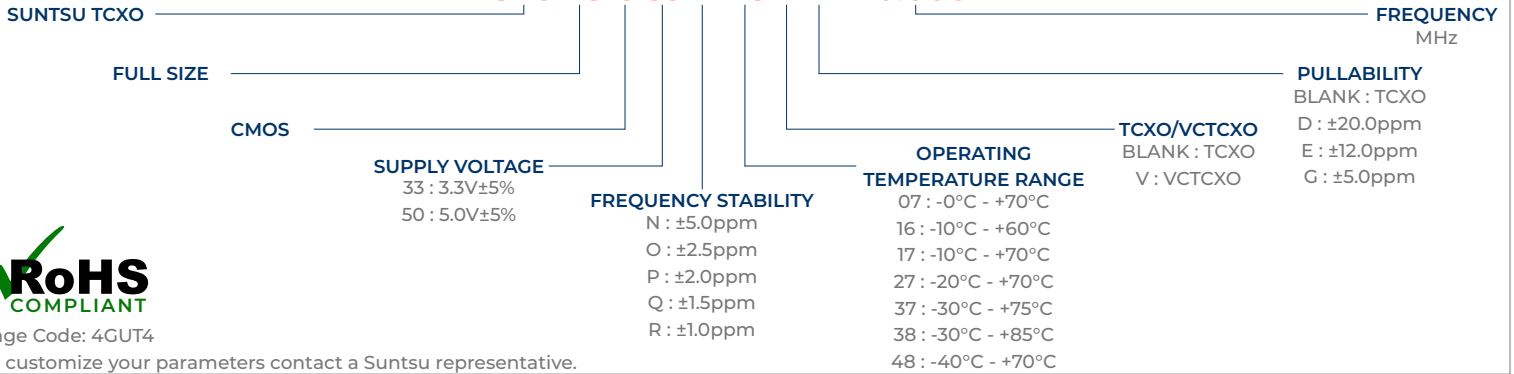

Cage Code: 4GUT4

To customize your parameters contact a Suntsu representative.

Electrical Parameters	Units	Minimum	Typical	Maximum	Remarks
Frequency Range	MHz	1		250	~160MHz at 5.0V
Frequency Tolerance at +25°C	ppm	-1.5		+1.5	
Freq. Stability vs. Op Temp.	ppm	-1.0		+1.0	See part numbering guide for options.
Freq. Stability vs. Supply Voltage	ppm	-0.3		+0.3	V <sub>DD</sub> ±5% Change
Freq. Stability vs. Load	ppm	-0.2		+0.2	±10% Change
Freq. Stability vs. Aging/Year	ppm	-1.0		1.0	1 year
Operating Temperature	°C	-40		+85	See part numbering guide for options.
Storage Temperature	°C	-55		+125	
Supply Voltage (V <sub>DD</sub> ) - 3.3V Option	V	3.135	3.3	3.465	
Supply Voltage (V <sub>DD</sub> ) - 5.0V Option	V	4.750	5.0	5.250	
Current (I <sub>DD</sub> )	mA			50	
Current (VC, VCTCXO) - 3.3V Option	V	0.3		3.0	
Current (VC, VCTCXO) - 5.0V Option	V	0.5		4.5	
Pullability (VCTCXO)	PPM	±5.0		±12.0	See part numbering guide for options.
Linearity (VCTCXO)	%			10	
Output Load (CMOS)	pF			15	
Output Logic Level - High (V <sub>OH</sub> )	V	0.9*V <sub>DD</sub>			
Output Logic Level - Low (V <sub>OL</sub> )	V			0.1*V <sub>DD</sub>	
Rise (T <sub>R</sub> ) And Fall (T <sub>F</sub> ) Time	ns			5	
Symmetry (Duty Cycle)	%	40	50	60	
Start-Up Time	ms			3	
Frequency Adjustment	ppm	-3		+3	
Phase Noise (Typical) 10Hz Offset	dBc/Hz		-80		
Phase Noise (Typical) 100Hz Offset	dBc/Hz		-120		
Phase Noise (Typical) 1KHz Offset	dBc/Hz		-135		
Phase Noise (Typical) 10KHz Offset	dBc/Hz		-140		
Phase Noise (Typical) 100KHz Offset	dBc/Hz		-145		

**Outline Drawing & Part Marking**

All dimensions are in millimeters (mm) unless otherwise noted. Drawings are not to scale.

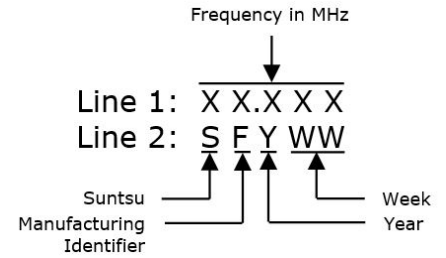
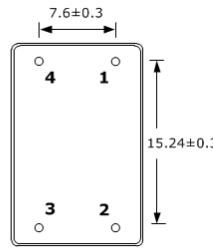
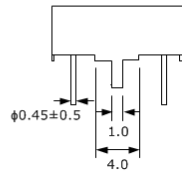
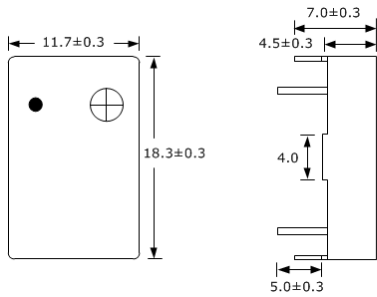

PIN	FUNCTION
1	V <sub>c</sub> (VCTCXO) or NC (TCXO)
2	GND
3	OUTPUT
4	V <sub>DD</sub>

**Test Circuit (CMOS)**

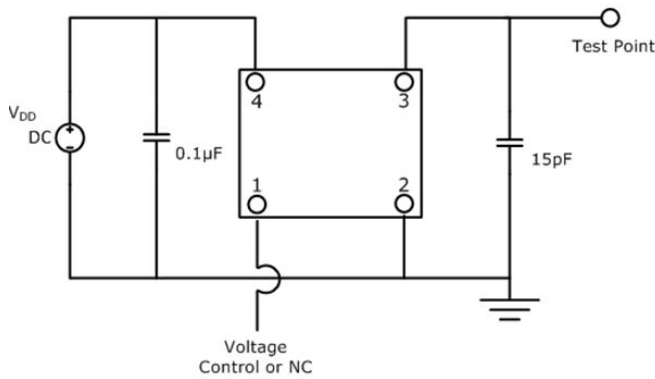

**Waveform (CMOS)**

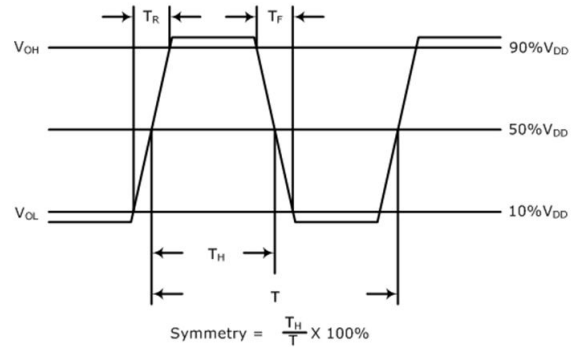

**Typical Phase Noise And Jitter Performance (Measured By Agilent E5052A)**

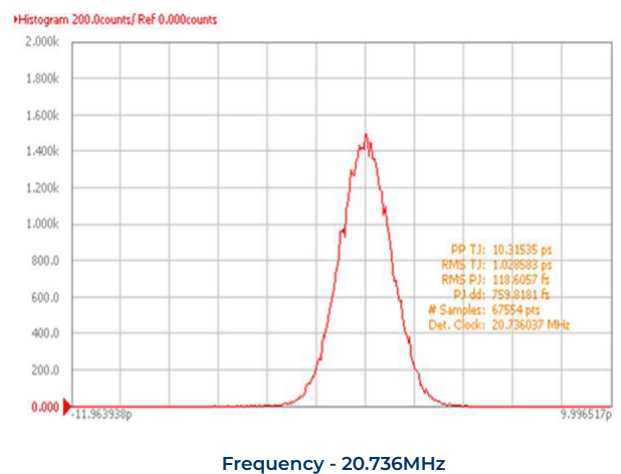
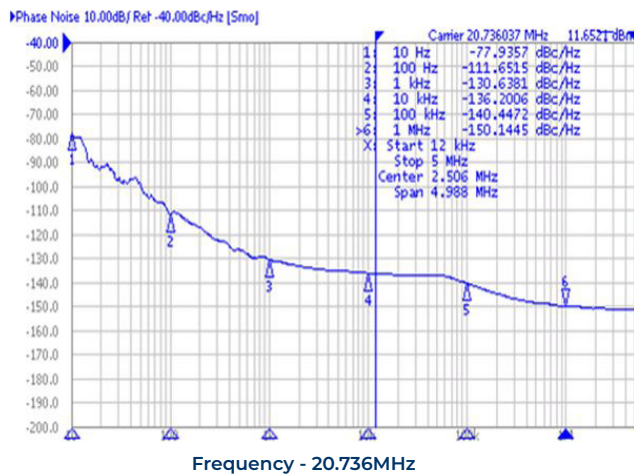

Environmental Specifications		Mechanical Specifications	
Temperature Cycling	MIL-STD-883, Method 1010, Condition B	Mechanical Shock	MIL-STD-202, Method 213, Condition B
Fine Leak Test	MIL-STD-883, Method 1014, Condition A	Vibration	MIL-STD-883, Method 2007, Condition A
Gross Leak Test	MIL-STD-883, Method 1014, Condition C	Moisture Resistance	MIL-STD-883, Method 1004
Solderability	MIL-STD-883, Method 2003	Resistance to Solvents	MIL-STD-202, Method 215
Moisture Sensitivity	J-STD-020, MSL 1	Resistance to Soldering Heat	MIL-STD-202, Method 210, Condition K