

Features
<ul style="list-style-type: none"> • Magnetic Shielded Structure • Composite Structure • Ultra Low Buzz Noise • Low Loss, High Efficiency, Wide Application Frequency • Lightweight Design, High Density SMD

Applications
<ul style="list-style-type: none"> • Use in Buck Converter • Laptops • Displayer • Network Communication Equipment

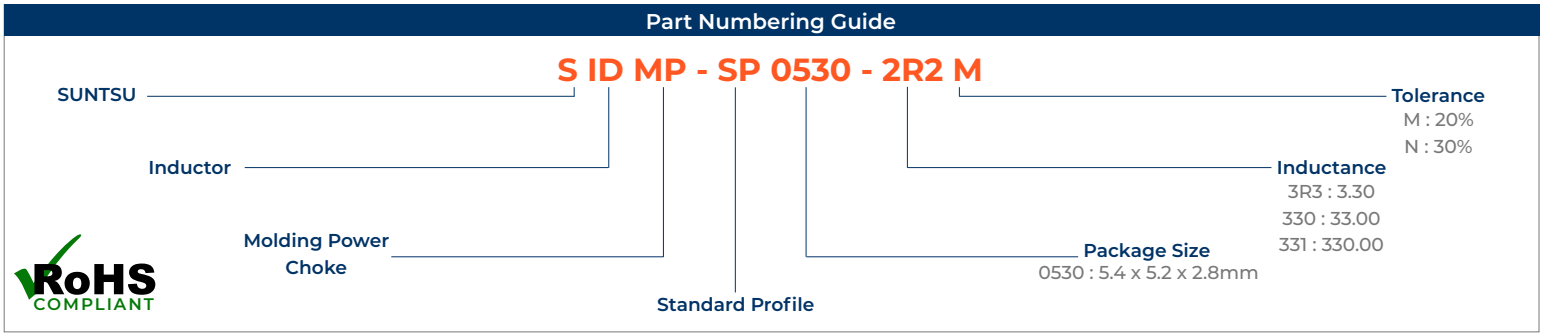
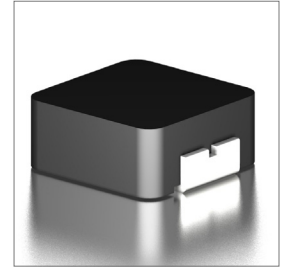

Part Number	Inductance (μH)	Tolerance	D.C.R. (mΩ) Typical	D.C.R. (mΩ) Max	Saturation Current (A) Typical	Temp. Rise Current (A) Typical
SIDMP-SP0530-R22M	0.22	±20%	3.30	4.00	19.00	16.30
SIDMP-SP0530-R33M	0.33	±20%	4.80	5.60	15.00	13.50
SIDMP-SP0530-R47M	0.47	±20%	8.80	11.00	14.00	10.00
SIDMP-SP0530-R68M	0.68	±20%	9.30	12.00	12.00	9.70
SIDMP-SP0530-1R0M	1.00	±20%	11.70	14.00	12.00	8.70
SIDMP-SP0530-1R5M	1.50	±20%	16.20	23.00	12.00	7.40
SIDMP-SP0530-2R2M	2.20	±20%	25.50	29.00	9.50	5.90
SIDMP-SP0530-3R3M	3.30	±20%	35.80	42.00	6.00	5.00
SIDMP-SP0530-4R7M	4.70	±20%	52.40	60.00	5.00	4.10
SIDMP-SP0530-5R6M	5.60	±20%	57.10	65.00	4.50	3.90
SIDMP-SP0530-6R8M	6.80	±20%	82.00	90.00	4.00	3.30
SIDMP-SP0530-8R2M	8.20	±20%	109.00	120.00	4.00	2.80
SIDMP-SP0530-100M	10.00	±20%	117.00	125.00	4.00	2.60
SIDMP-SP0530-150M	15.00	±20%	171.00	210.00	3.00	2.40
SIDMP-SP0530-220M	22.00	±20%	190.00	248.00	2.30	2.00

Saturation Current vs Temperature Rise Current Curve

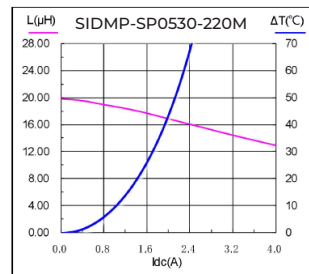
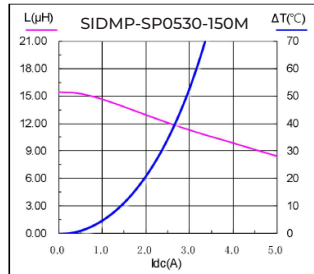
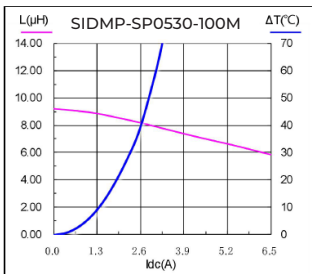
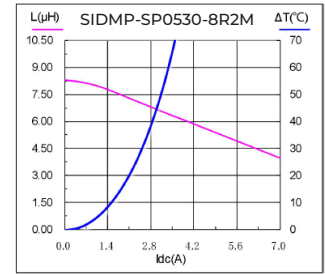
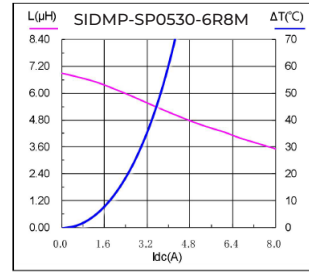
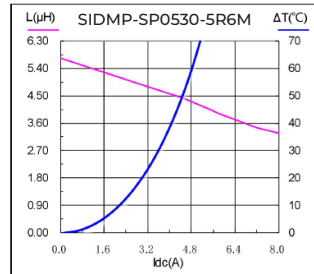
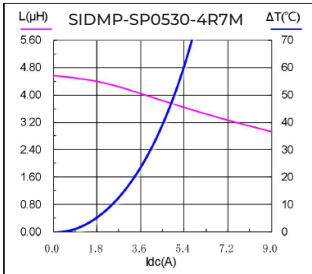
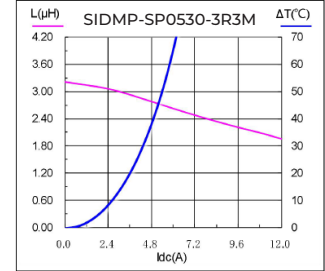
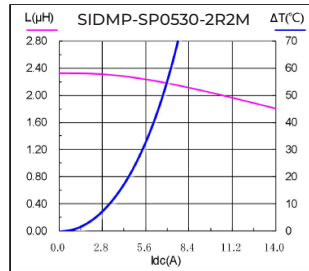
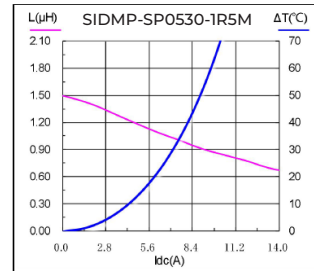
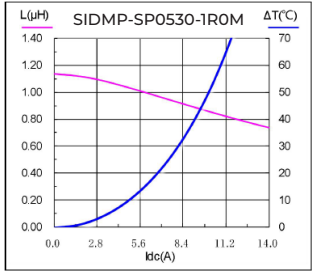
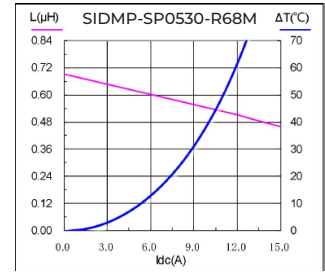
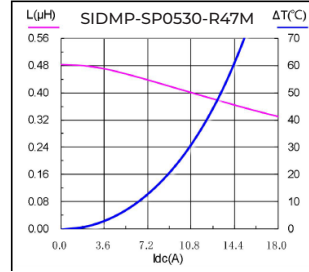
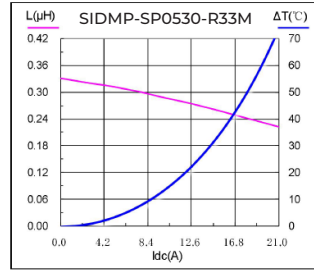
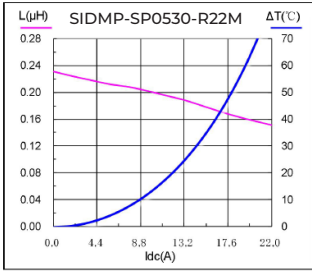

- All Data is tested based on 25°C ambient temperature.
- Inductance measure condition at 100kHz, 1.0V.
- Saturation current: The actual value of DC current when the inductance decrease 30% of its initial value.
- Temperature rise current: The actual value of DC current when the temperature rise is $\Delta T 40^{\circ}$ C ($T_a=25^{\circ}$ C).
- Reminder: Circuit design, component placement, PCB size and thickness, cooling system and etc. will all affect the product temperature.
- Please verify the product temperature in the final application.

Outline Drawing & Land Pattern

All dimensions are in millimeters (mm) unless otherwise noted. Drawings are not to scale.

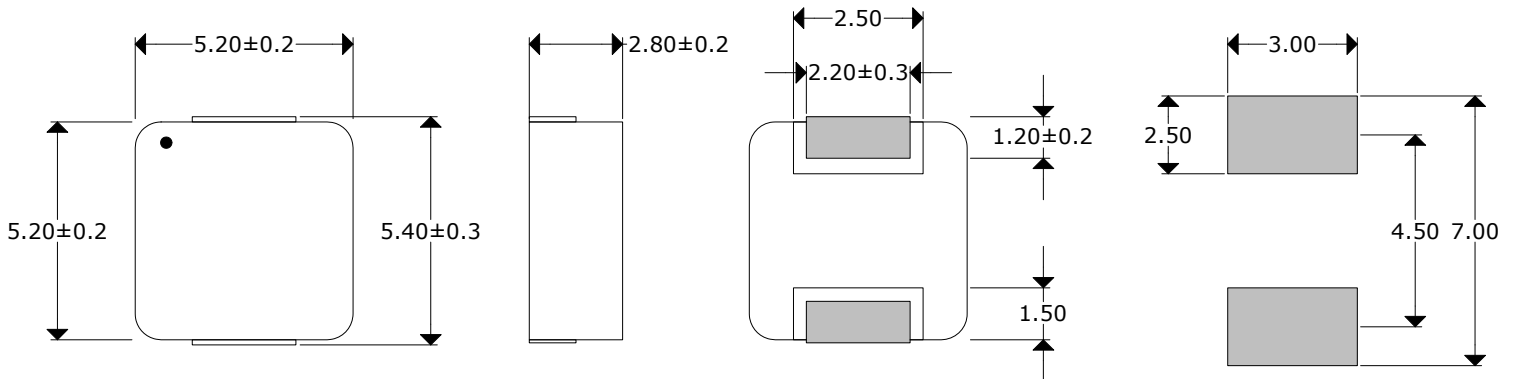

Reflow Profile & Part Marking

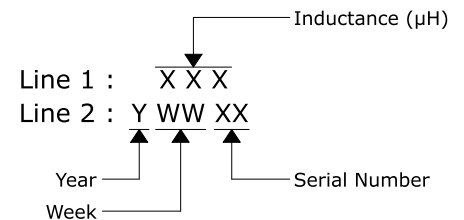
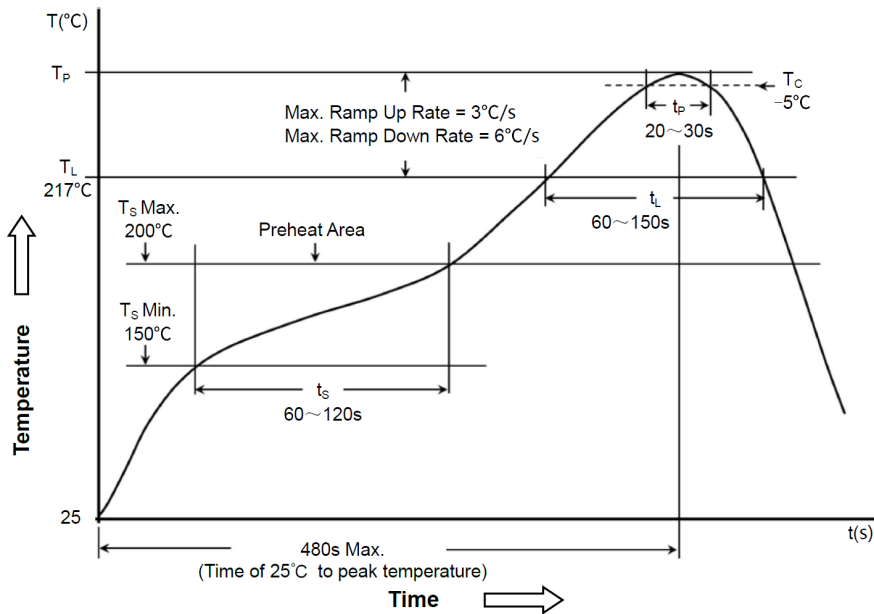

Year Letter Code:

- X : 2020
- Y : 2021
- A : 2022
- B : 2023

Inductance Example:

- 3.30µH : 3R3
- 33.00µH : 33R
- 330.00µH : 331
- 3300.00µH : 332

Classification of Peak Package Body Temperature (Tp)

	Package Thickness	Package Volume		
		<350 mm ³	350~2000 mm ³	>2000 mm ³
PB-Free Assembly	<1.6mm	260°C	260°C	260°C
	1.6~2.5mm	260°C	250°C	245°C
	≥2.5mm	250°C	245°C	245°C

Tape And Reel Dimensions

All dimensions are in millimeters (mm) unless otherwise noted. Drawings are not to scale.

2000pcs / Reel

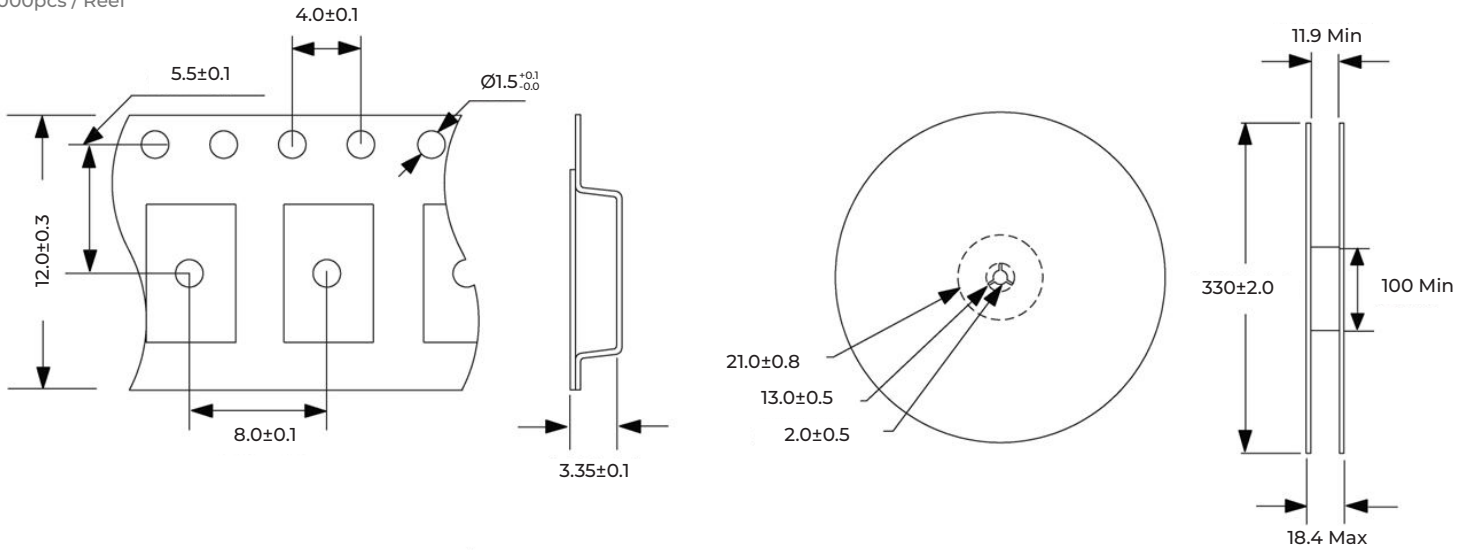

Environmental Specifications

Temperature Cycling	MIL-STD-883, Method 1010, Condition B
Fine Leak Test	MIL-STD-883, Method 1014, Condition A
Gross Leak Test	MIL-STD-883, Method 1014, Condition C
Moisture Resistance	MIL-STD-883, Method 1004
Moisture Sensitivity	J-STD-020, MSL 1

Mechanical Specifications

Mechanical Shock	MIL-STD-202, Method 213, Condition C
Vibration	MIL-STD-883, Method 2007, Condition A
Resistance to Soldering Heat	MIL-STD-202, Method 210, Condition K
Resistance to Solvents	MIL-STD-202, Method 215
Solderability	MIL-STD-883, Method 2003

Notice of Use

1. Product in packing storage condition : temperature 5~40°C, RH ≤ 70%.	6. When this product will be used on a similar or new project to the original one, sometimes it might be unable to satisfy the specifications due to different condition of usage.
2. A storage of inductors longer than 12 months is not recommended. Within other effects, the terminals may suffer degradation, resulting in bad solderability. Therefore, all products shall be used within the period of 12 months based on the day of shipment.	7. This inductor itself does not have any protective function in abnormal condition, such as overload, short-circuit, open-circuit conditions, etc. Therefore, it shall be confirmed that there is no risk of smoke, fire, dielectric withstand voltage, insulation resistance, etc. or use in abnormal conditions protective devices or protection circuit in the end product.
3. Do not keep products in unsuitable storage conditions, such as areas susceptible to high temperatures, high humidity, dust or corrosion.	8. Hi-Pot test with higher voltage than spec will damage material and shorten its life.
4. Always handle product with care.	9. If using in potting compound, the magnet wire coating might be damaged.
5. Don't touch electrodes directly with bare hands as oil secretions may inhibit soldering. Always ensure optimum conditions for soldering.	10. Refrain from rinsing coils.