

# SCNUS - UC - 124SGF - SOVPM

Suntsu Connector      USB      USB-C      Number of Ports      Number of Contacts      Contact Plating Selective Gold      Female      Termination Style Solder      Mounting Angle Vertical      Mounting Style PCB Mount

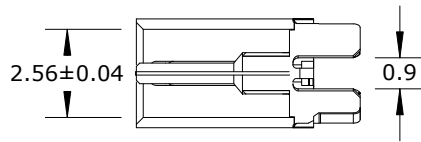
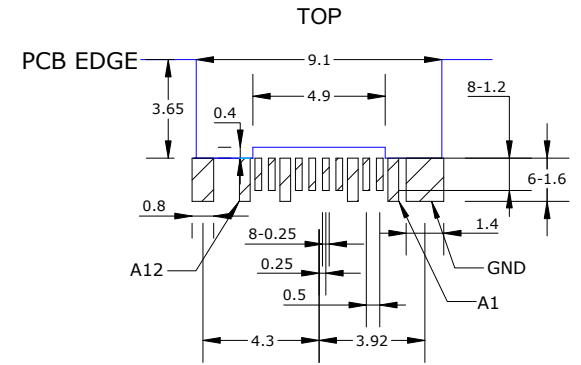
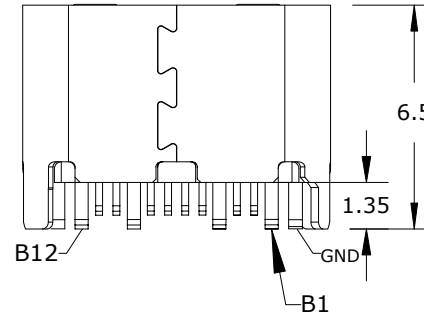
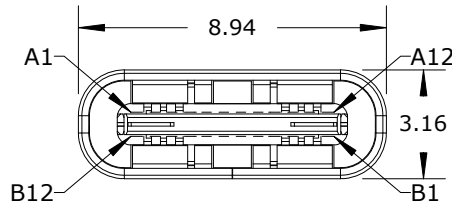
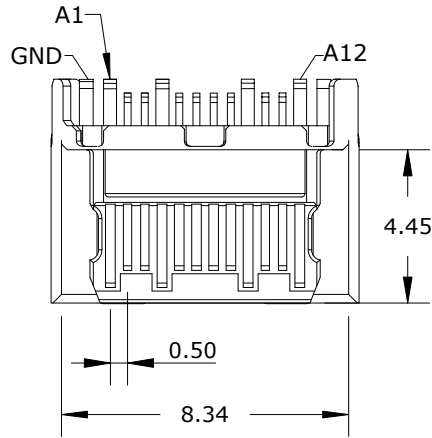
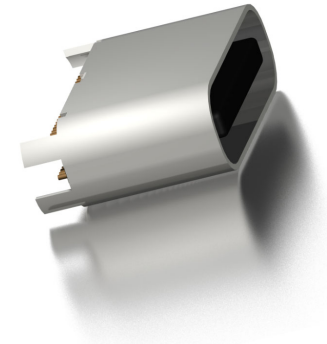

Pin Functions

|    |      |     |      |    |      |     |      |
|----|------|-----|------|----|------|-----|------|
| A1 | GND  | A7  | D-   | B1 | GND  | B7  | D-   |
| A2 | TX1+ | A8  | SBU1 | B2 | TX2+ | B8  | SBU2 |
| A3 | TX1- | A9  | Vbus | B3 | TX2- | B9  | Vbus |
| A4 | Vbus | A10 | RX2- | B4 | Vbus | B10 | RX1- |
| A5 | CC1  | A11 | RX2+ | B5 | CC2  | B11 | RX1+ |
| A6 | D+   | A12 | GND  | B6 | D+   | B12 | GND  |

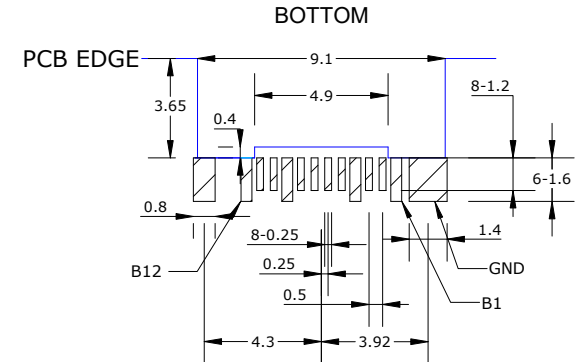

**Specification**  
 Current Rating: 5 AMP for VBUS Pin  
 1.25 AMP for VCONN Pin  
 Contact Resistance: 40mΩ Max.  
 Insulation Resistance: 100MΩ Min.  
 Dielectric Voltage: 100V AC for one minute  
 Operation Temperature: -25°C to 85°C  
 Insertion Force: 5N ~ 20N  
 Withdrawl Force: 8N ~ 20N



**USB TYPE C 3.1  
 FEMALE CONNECTOR**

| Document History |            |            |             | Part No.              | Drawn                 |
|------------------|------------|------------|-------------|-----------------------|-----------------------|
| Edits Made       | Date       | Edited By  | Approved By | SCNUS-UC-124SGF-SOVPM | B. Gibbons 01/26/2021 |
| Initial Release  | 01/26/2021 | B. Gibbons | KH Mun      | Scale                 | Tolerance             |
|                  |            |            |             | Not drawn to scale    | .X ±0.30              |
|                  |            |            |             | Unit                  | .XX ±0.20             |
|                  |            |            |             | mm                    | Pages                 |
|                  |            |            |             |                       | 1/1                   |