

Features
<ul style="list-style-type: none"> • Miniature Footprint • Low Insertion Loss • High Attenuation on Harmonic Suppressed • LTCC Process

Applications
<ul style="list-style-type: none"> • 1520-1610MHz Working Frequency • Private 5G Network

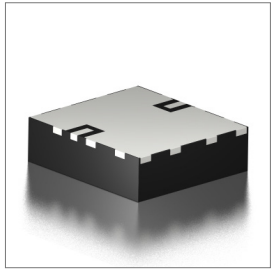

Part Numbering Guide

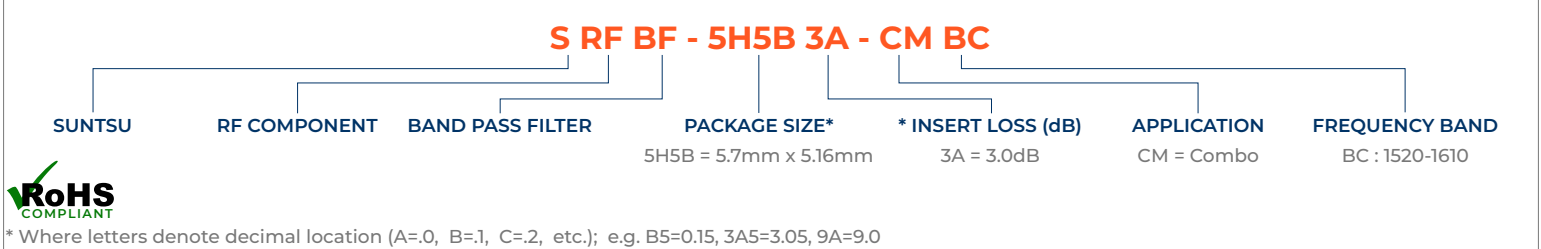

Electrical Parameters	Units	Minimum	Typical	Maximum	Remarks
Frequency	MHz	1520		1610	
Insertion Loss @ 25°C	dB			3.0	
Return Loss	dB	12.0			
Impedance	Ω		50		
Power Capacity	W			3	
Operating Temperature Range	°C	-40		85	
Storage Temperature Range	°C	-40		85	
Attenuation @ DC~960MHz	dB	40			
Attenuation @ 1100~1300MHz	dB	20			
Attenuation @ 1700~1950MHz	dB	30			
Group Delay @ 1559~1563MHz	ns		5.0		
Group Delay @ 1565~1585MHz	ns		5.0		
Group Delay @ 1598~1606MHz	ns		5.0		

Outline Drawing

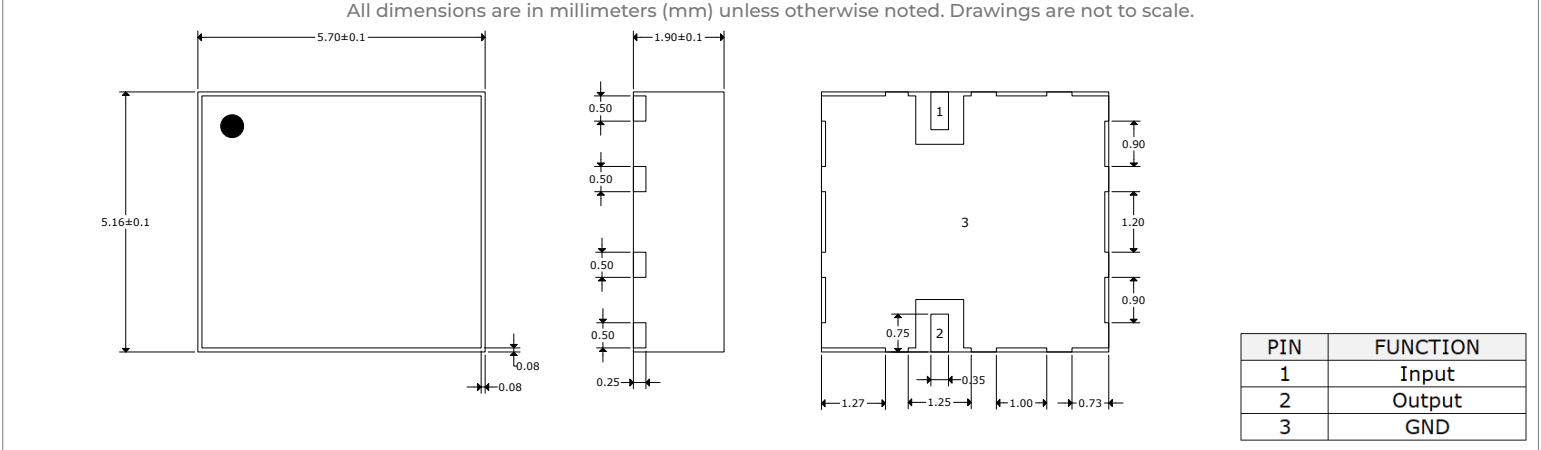

Typical Electrical Chart

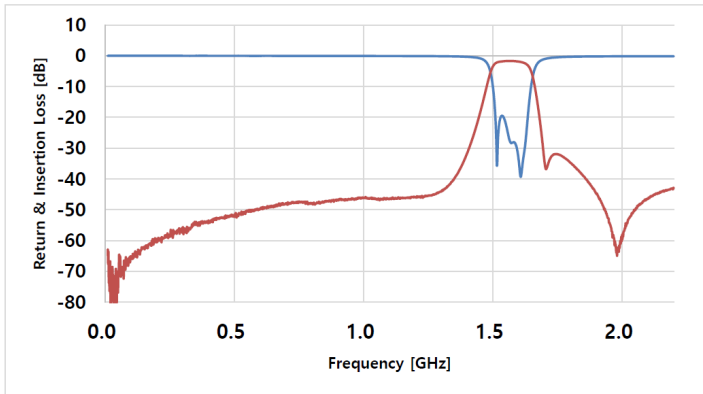

Land Pattern

All dimensions are in millimeters (mm) unless otherwise noted. Drawings are not to scale.

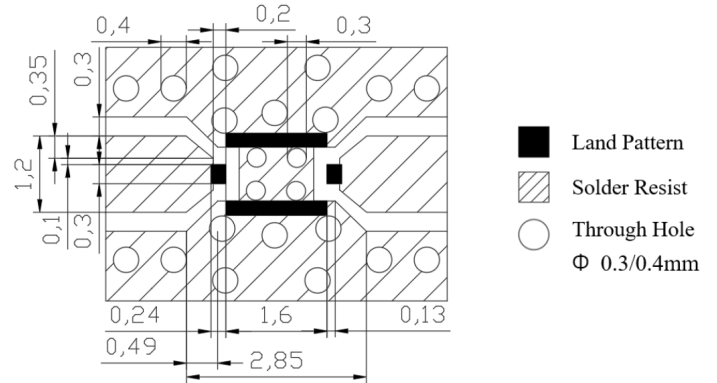

Line width to be designed to match 50Ω characteristic impedance, depending on PCB material and thickness.

Test Circuit

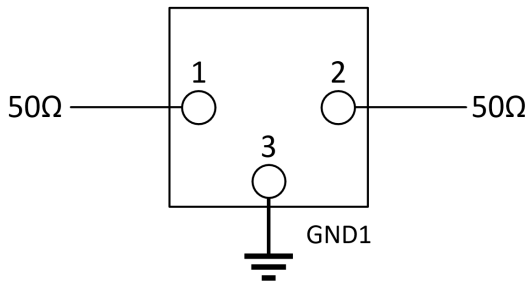

Reflow Profile

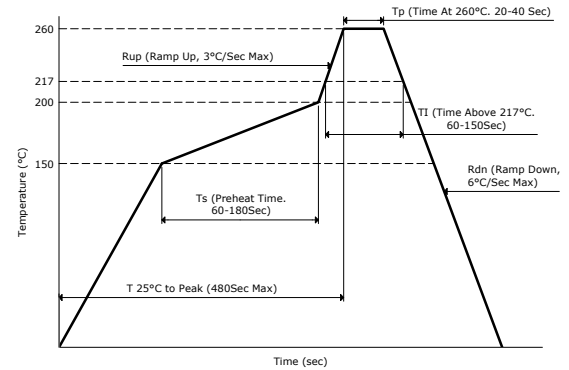

Tape and Reel Dimensions

All dimensions are in millimeters (mm) unless otherwise noted. Drawings are not to scale.

3,000 pcs/reel

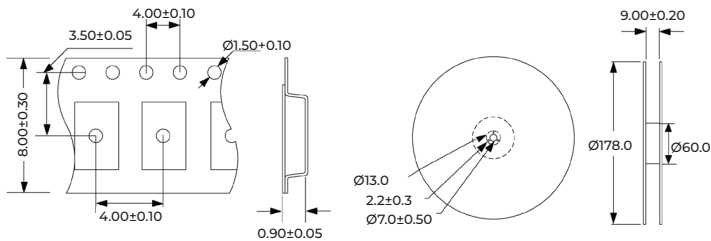

Markings

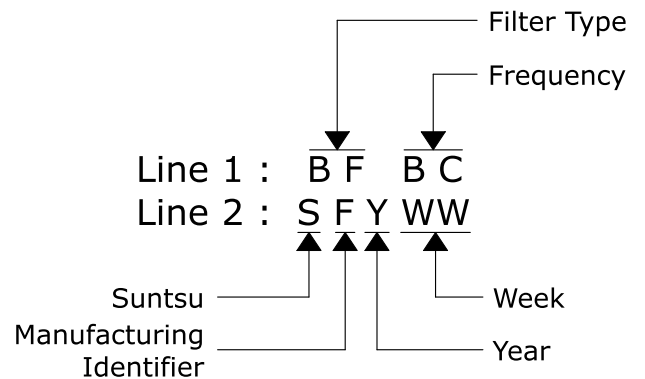

Reliability Test		
Test Item	Test Conditions/Test Method	Specification
Solderability JIS C 0050-4.6 JESD22-B1D	*Solder bath temperature : 235±5°C *Immersion time : 2±0.5 sec Solder : Sn ³ Ag 0.5Cu for lead-free	At least 95% of a surface of each terminal electrode must be covered by fresh solder.
Leaching (Resistance to dissolution of metallization) IEC 60068-2-58	*Solder bath temperature : 260±5°C *Leaching immersion time : 30±0.5 sec Solder : SN63A	Loss of metallization on the edges of each electrode shall not exceed 25%
Resistance to soldering heat JIS C 0050-5.4	*Preheating temperature : 120~150°C, 1 minute *Solder temperature : 270±5°C *Immersion time : 10±1 sec Solder : Sn3Ag 0.5Cu for lead-free Measurement to be made after keeping at room temperature for 24±2 hrs.	No mechanical damage. Electrical specification shall satisfy the descriptions in electrical characteristics under the operational temperature range within -40~85°C. Loss of metallization on the edges of each electrode shall not exceed 25%
Drop Test JIS C 0044	*Height : 75 cm *Test surface : Rigid surface of concrete or steel. *Times : 6 surfaces for each unit; 2 times each side.	No mechanical damage. Electrical specification shall satisfy the description in electrical characteristics under the operational temperature range within -40~85°C.
Vibration JIS C 0040	*Frequency : 10Hz~55Hz~10Hz (1 min) *Total amplitude : 1.5mm *Test times : 6hrs (two hrs each in three mutually perpendicular directions)	No mechanical damage. Electrical specification shall satisfy the descriptions in electrical characteristics under the operational temperature range within -40~85°C.
Adhesive Strength of Termination JIS C 0051-7.4.3	*Pressurizing force : 5N(≤603) ; 10N(>0603) *Test time : 10±1 sec	No remarkable damage or removal of the termination
Bending Test JIS C 0051-7.4.1	The middle part of substrate shall be pressurized by means of the pressurizing rod at a rate of about 1mm/s per second until the deflection becomes 1mm/s and then pressure shall be maintained for 5±1 sec. Measurement to be made after keeping at room temperature for 24±2 hours.	No mechanical damage. Electrical specification shall satisfy the descriptions in electrical characteristics under the operational temperature range within -40~85°C.
Temperature Cycle JIS C 0025	1. 30±3 minutes at -40°C±3°C 2. 10~15 minutes at room temperature 3. 30±3 minutes at 85°C±3°C 4. 10~15 minutes at room temperature Total 100 continuous cycles Measurement to be made after keeping at room temperature for 24±2 hours.	No mechanical damage. Electrical specification shall satisfy the descriptions in electrical characteristics under the operational temperature range within -40~85°C.
High Temperature JIS C 0021	*Temperature : 85°C±2°C *Test duration : 1000+24/-0 hours Measurement to be made after keeping at room temperature for 24±2 hours.	No mechanical damage. Electrical specification shall satisfy the descriptions in electrical characteristics under the operational temperature range within -40~85°C.
Humidity (steady conditions) JIS C 0022	*Humidity : 90% to 95% Relative Humidity *Temperature : 40°C±2°C *Time : 1000+24/-0 hours Measurement to be made after keeping at room temperature for 24±2 hours. **500hrs measuring the first data then 1000hrs data	No mechanical damage. Electrical specification shall satisfy the descriptions in electrical characteristics under the operational temperature range within -40~85°C.
Low Temperature JIS C 0020	*Temperature : -40°C±2°C *Test duration : 1000+24/-0 hours Measurement to be made after keeping at room temperature for 24±2 hours.	No mechanical damage. Electrical specification shall satisfy the descriptions in electrical characteristics under the operational temperature range within -40~85°C.